

# EPS4019F-LCD - WIRELESS DISPLAY

SISTEMA DI PARCHEGGIO ANTERIORE A 4 SENSORI (FS)  
(SISTEMA POSTERIORE CON PONTICELLO UNITA' SLAVE INTERROTTO)  
FRONT PARKING SYSTEM WITH 4 SENSORS (FS)  
(REAR PARKING WITH WIRE LOOP COT ON SLAVE UNIT)

## Composizione del Kit / Kit Composition

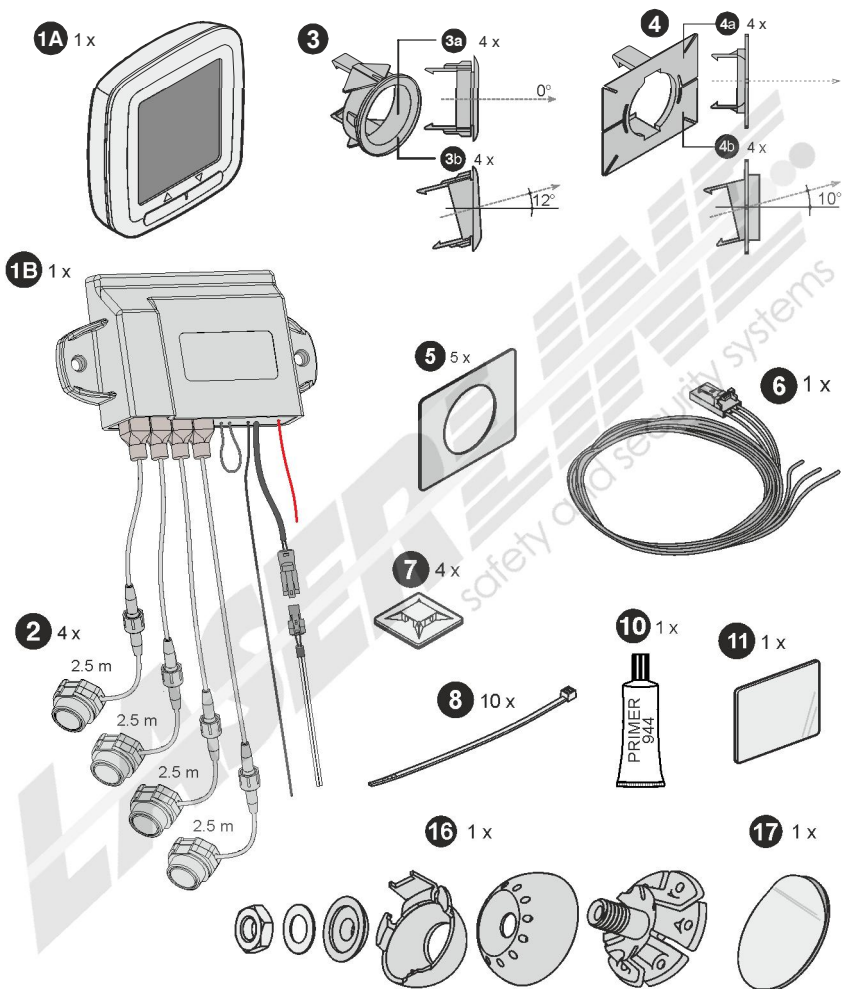

## Attrezzature necessarie Equipment needed

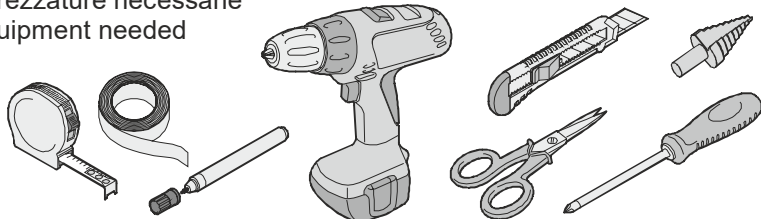

## VERNICIATURA SENSORI / SENSORS PAINTING

**A1**

**Spray ancorante per plastica / Plastic anchoring (primer)**

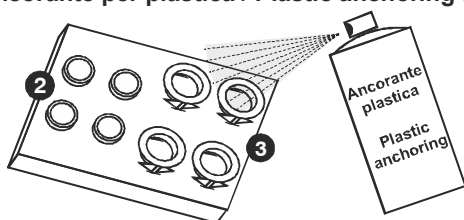

Attendere il tempo indicato sulla bomboletta spray prima di procedere con la verniciatura.

Wait for the time indicated on the spray before proceeding with painting.

**A2**

**Vernice spray / Spray paint**

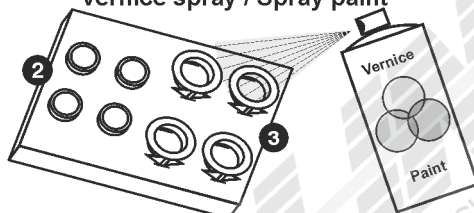

Attendere il tempo indicato sulla bomboletta spray prima di procedere con la verniciatura trasparente.

Wait for the time indicated on the spray before proceeding with the transparent painting.

**A3**

**Vernice trasparente / Transparent paint**

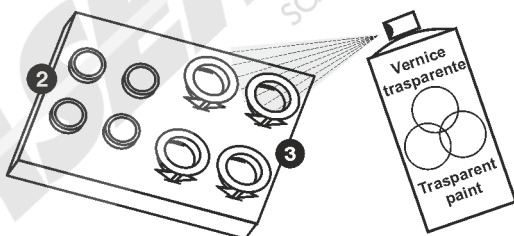

Solo quando la vernice è asciutta rimuovere e rimettere l'anello plastico.

Only when the paint is dry, remove and replace the plastic cover.

**A4**

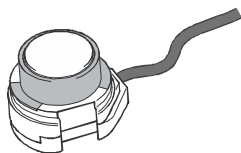

18 mm  
con anello / with ring

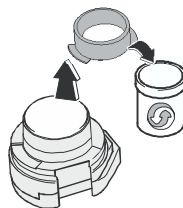

16 mm  
senza anello / without ring

**AVVERTENZE PER L'INSTALLAZIONE 4019-LCD POSTERIORE**  
**Ponticello marrone della centralina slave interrotto**  
**INSTALLATION NOTE 4019-LCD REAR**  
**SLAVE unit with brown wire loop cut**

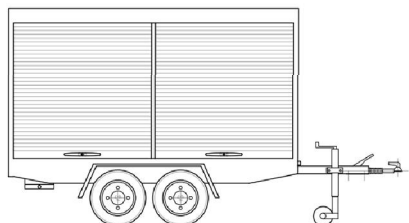

Nel caso venisse collegato un rimorchio e/o porta bicicletta è possibile escludere la loro rilevazione fornendo un segnale di massa al filo giallo/nero della centralina SLAVE.

In case a trailer and/or carrier bike is connected, it is possible to exclude the detection by providing a ground signal to yellow/black wire of the SLAVE unit.



Onde evitare false segnalazioni, per l'installazione su paraurti in metallo è obbligatorio utilizzare i supporti in gomma opzionali oppure, per un'installazione a filo, utilizzare l'articolo KIT-PPGUS3-SMB1 Gasket (Optional).

To avoid false detections, for the installation on a metal bumper it's mandatory to use the adapter art. KIT-PPGUS3-SMB1 Gasket (optional).

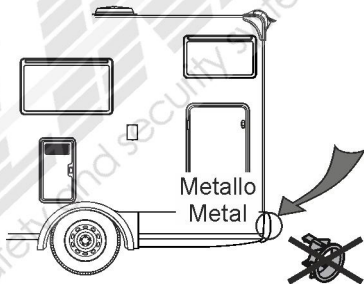

Per eliminare eventuali disturbi dati da sporgenze presenti dietro al veicolo come gancio traino, porta-bici, scaletta, ecc. si consiglia di consultare il manuale per impostare il parametro corretto. (regolazione parametro n.11 o n.17).

For vehicles with rear projections, bike carrier and/or towbar, please examine the instructions manual (parameter setting n.11 or n.17).

**B1**

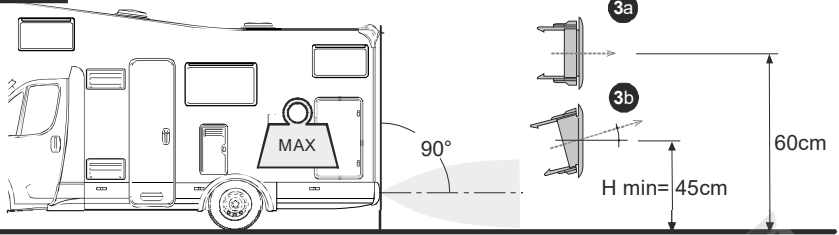

**B2**

4 sensori posteriori standard / 4 rear standard sensors

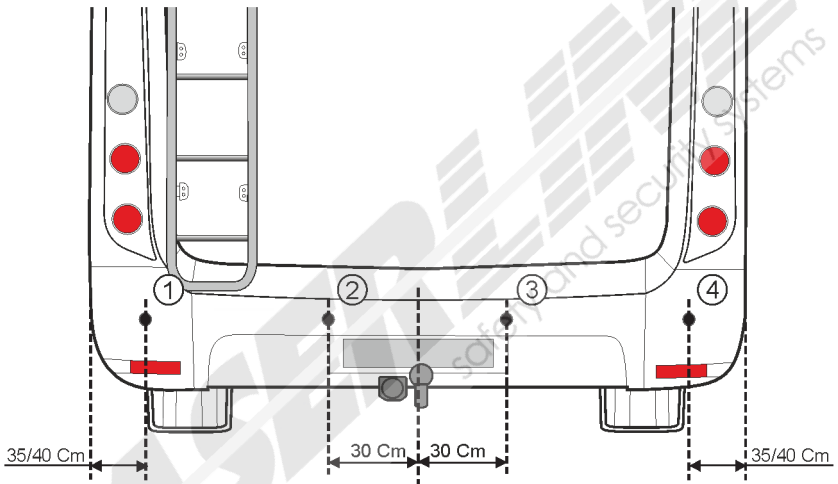

D1

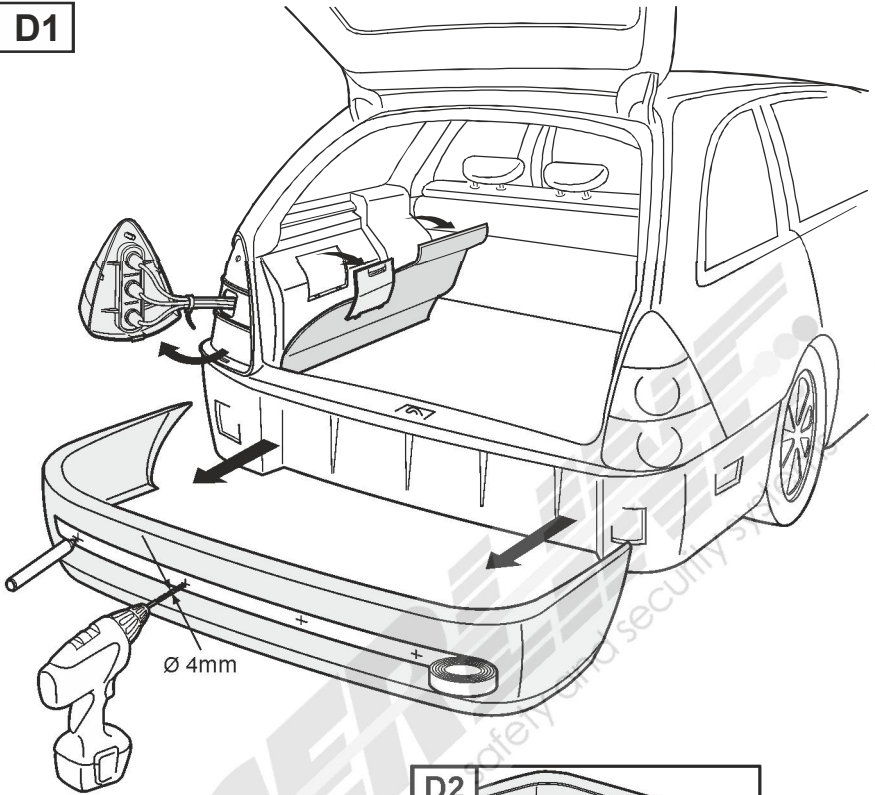

Ø 4mm

D2

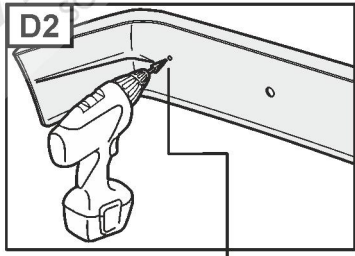

OPTIONAL AL18  
"Raccomandato"  
"Recommended"

OPTIONAL

18mm

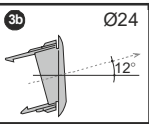
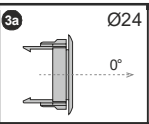
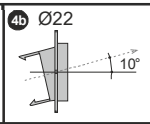
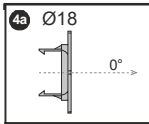
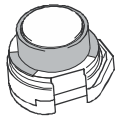

16mm

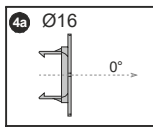
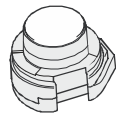

OPTIONAL AL16  
"Raccomandato"  
"Recommended"

D3

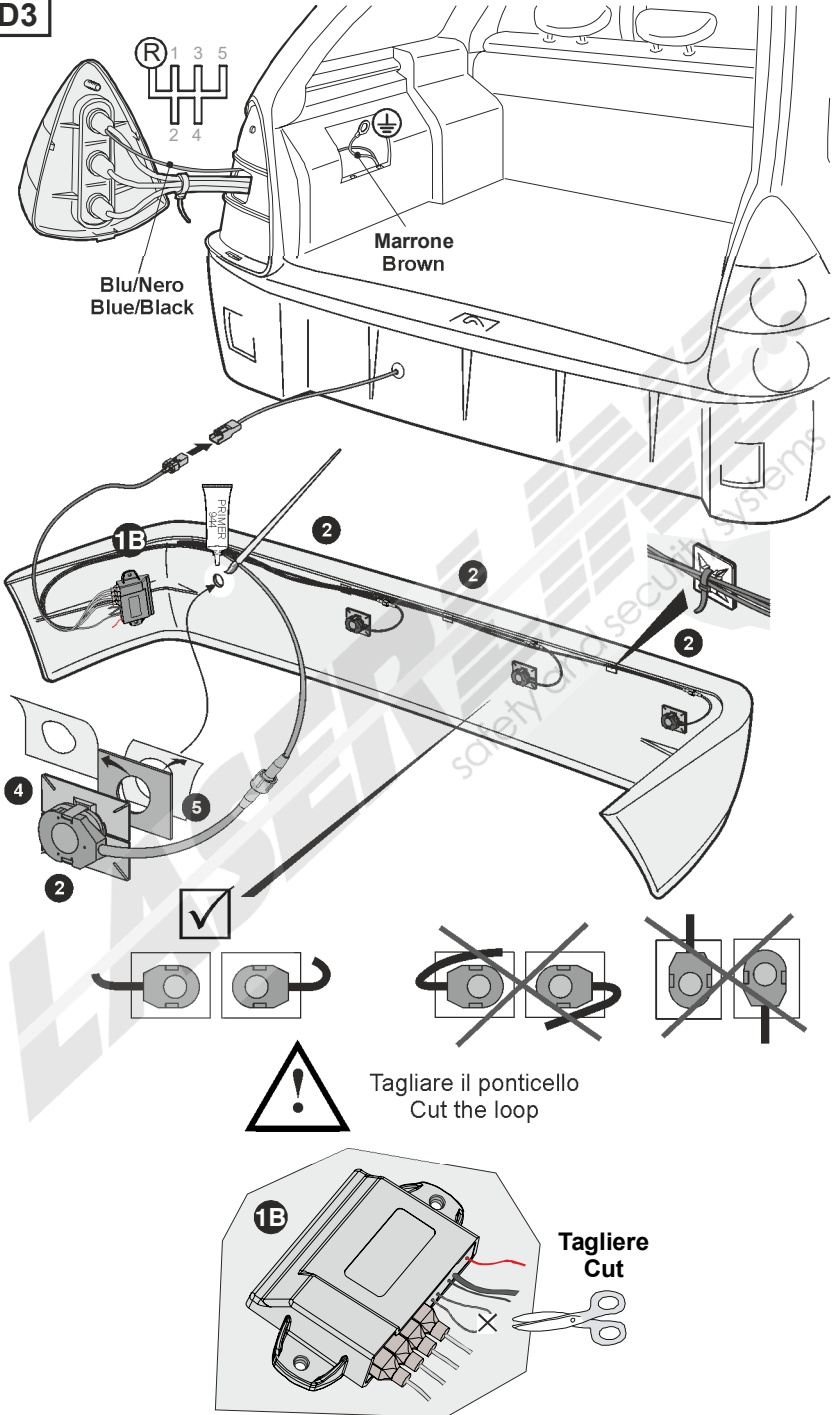

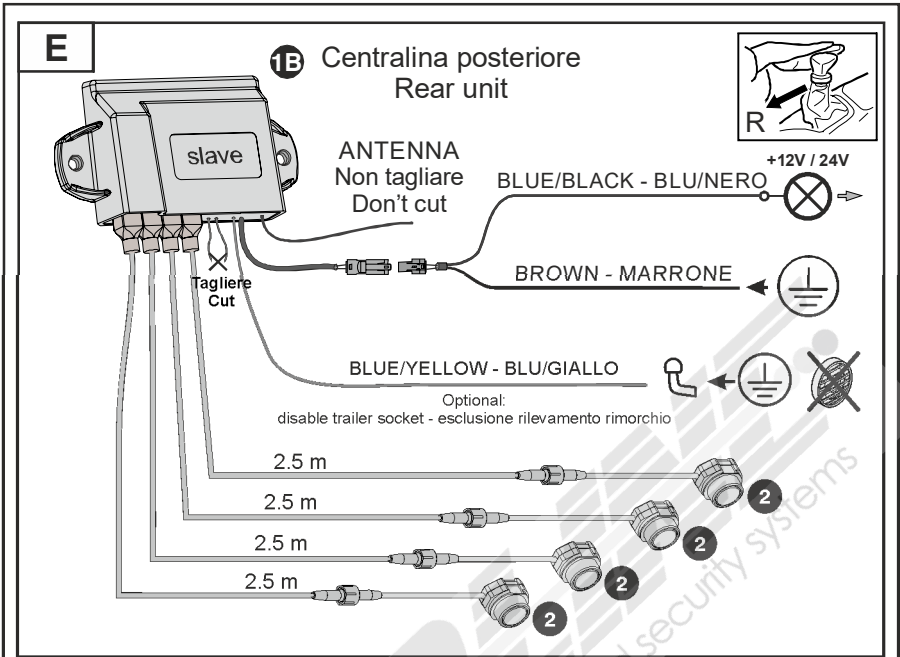

MODALITÀ DI COLLEGAMENTO / CONNECTION

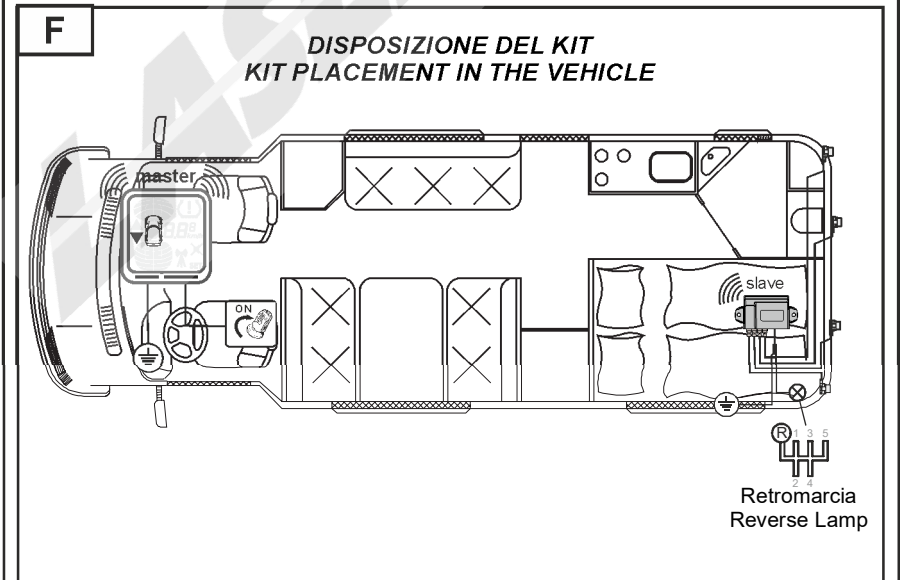

# POSIZIONAMENTO DISPLAY / DISPLAY POSITION

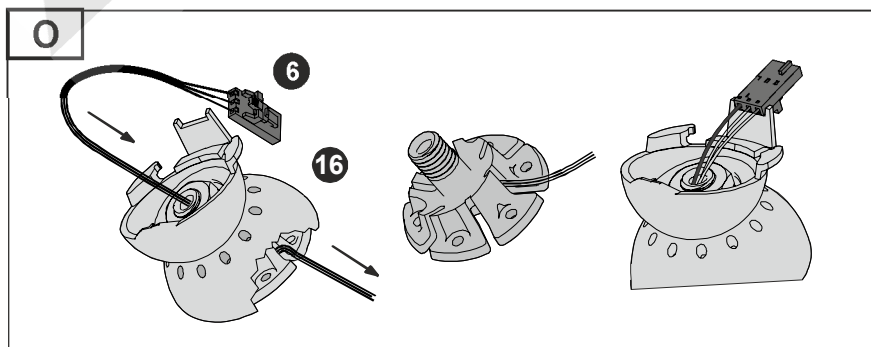
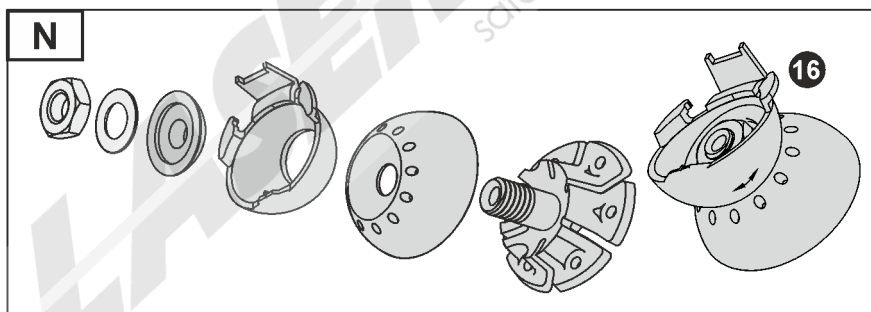
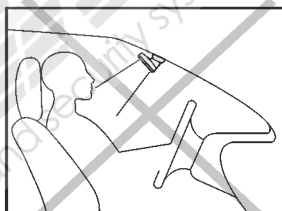
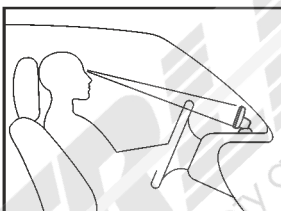
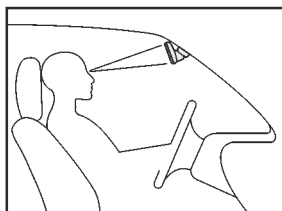
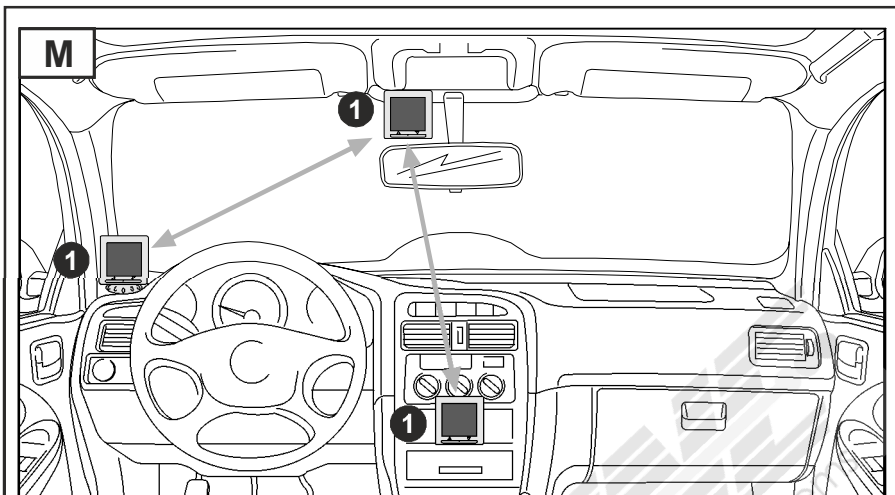



# POSIZIONAMENTO DISPLAY / DISPLAY POSITION

P

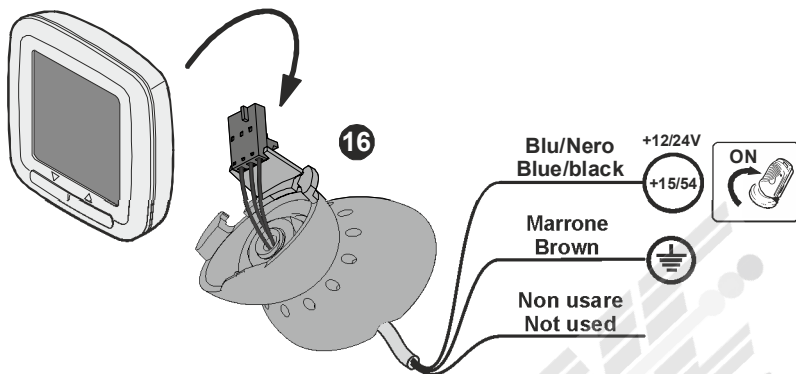

Q1

17

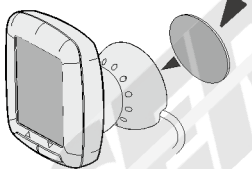
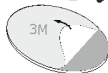

Q2

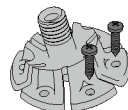
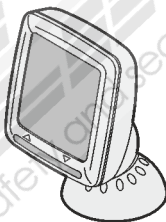

R

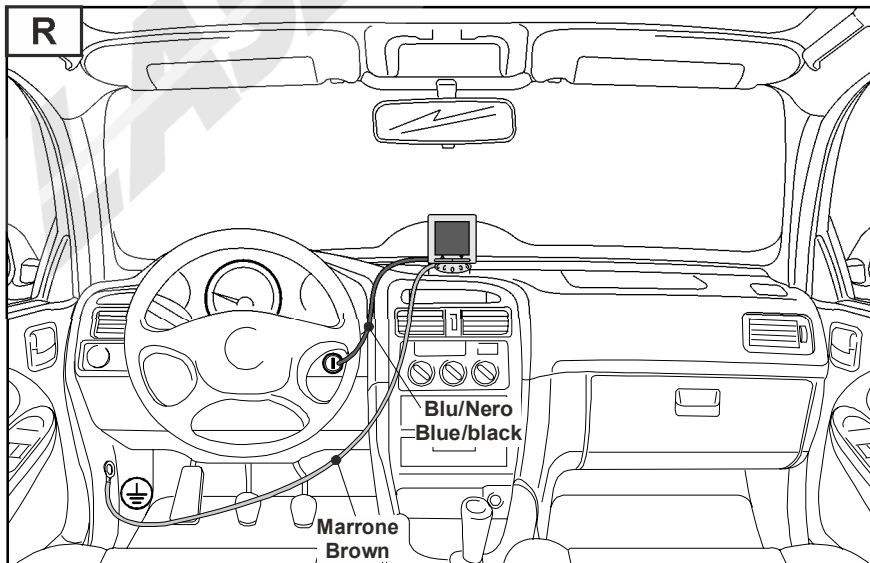

Le centraline utilizzano il sistema "senza fili" per dialogare tra loro. Il display deve riconoscere le centraline installate nello stesso veicolo, apprendendo il loro codice univoco di identificazione.

### Procedura di apprendimento della centralina al display

Accendere il quadro vettura ed inserire la retromarcia, solo ora premere per 2sec. entrambi i pulsanti sul display; apparirà la scritta "LE" (A), dopodiché l'icona con il simbolo "freccia inferiore" apparirà nella parte sinistra del display (B) così ad identificare il corretto apprendimento della centralina posteriore.

Ora la centralina è appresa al sistema, per confermare l'apprendimento spegnere il quadro della vettura.



(A)



(B)

### VERIFICHE IMPORTANTI DOPO L'INSTALLAZIONE

Il sistema è impostato da fabbrica per il montaggio delle centraline nel lato guida dei paraurti. Se invece l'installazione della centralina viene effettuata sul lato passeggero occorre modificare le impostazioni di fabbrica per ottenere una corretta visualizzazione degli ostacoli sul display.

Cambiare quindi l'impostazione della funzione N.9 per la centralina posteriore.

**NOTA:** le funzioni programmabili non vengono cancellate ad ogni nuovo apprendimento se viene mantenuto lo stesso display.



unità slave  
per posteriore

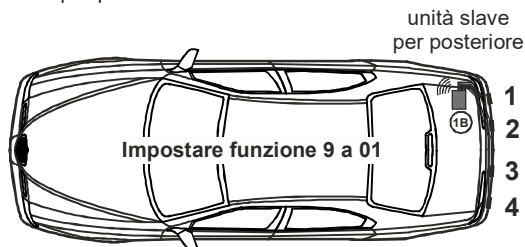

unità slave  
per posteriore

# IMPOSTAZIONE DELLE FUNZIONI

## Procedura di selezione

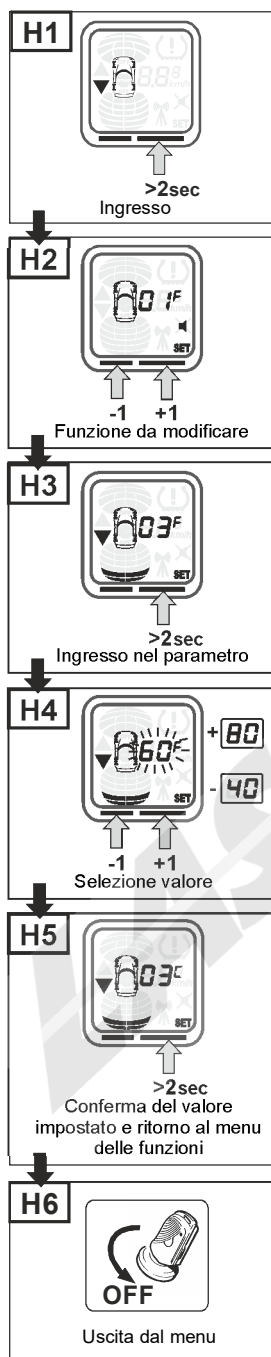

Funzione	Impostazione di fabbrica	Valori	Note
<b>01</b> → >2sec		DA <b>00</b> A <b>02</b>	<ul style="list-style-type: none"> <li>✕ 0=spento</li> <li>▲ 1=basso</li> <li>▼ 2=alto</li> </ul>
<b>02</b>			
<b>03</b> → >2sec		DA <b>20</b> A <b>80</b>	raggio di azione Nota, il display mostra 20-80
<b>04</b> → >2sec		DA <b>50</b> A <b>95</b>	raggio di azione sensori laterali
<b>05</b>			
<b>06</b> → >2sec		DA <b>35</b> A <b>70</b>	raggio di Stop posteriore
<b>07</b>			
<b>08</b>			
<b>09</b> → >2sec		DA <b>00</b> A <b>01</b>	00
<b>10</b> → >2sec		DA <b>01</b> A <b>05</b>	Colori display 1=rosso 2=verde 3=blu 4=ambra 5=bianco
<b>11</b> → >2sec		DA <b>00</b> A <b>03</b>	
<b>12</b>			
<b>13</b>			
<b>14</b>			
<b>15</b>			
<b>16</b>			
<b>17</b> → >2sec		DA <b>00</b> A <b>03</b>	0=Bassissima sensibilità 1=Bassa sensibilità post 2=Media sensibilità post 3=Alta sensibilità post.
<b>18</b> → >2sec		DA <b>00</b> A <b>02</b>	0= sistema Posteriore 1= sistema Anteriore 2= Selezione automatica

NUM.	DESCRIZIONE	RANGE	FACT. SET.	NOTE
1	volume dello speaker	0, 1, 2	2	0=spento, 1=basso, 2=alto
3	raggio dei sensori centrali posteriori	120 - 180 [cm]	160	il display mostra 20 - 80
4	raggio dei sensori laterali	50 - 95 [cm]	60	
6	zona STOP* posteriore	35 - 70 [cm]	35	
* ZONA STOP= distanza in cui bisogna arrestare il veicolo segnalato da un suono continuo. (Le distanze al di sotto di questo limite non sono più visualizzate)				
9	installazione centralina posteriore	0, 1	0	0 / 1 = sinistra/destra
10	colore illuminazione display	1 - 5	3	1 = rosso, 2 = verde 3 = blu, 4 = ambra, 5 = bianco
11	soppressione ruota di scorta esterna	0, 1, 2, 3	0	**
** NOTE: questa funzione permette di eliminare false segnalazioni di ostacoli dovute alla presenza di sporgenze come es. Ruota di scorta, gancio traino o altro.				
14	funzione supplementari display	0, 1, 2, 3, 4	0	0 = funzione non attiva 1 = controllo trasmissione 2 = Indicazione velocità 3 = impulsi odometrici 4 = Versione SW (0 - 9)
17	sensibilità lettura ostacoli posteriore	0, 1, 2, 3	1	0=molto bassa 1=bassa, 2=media, 3=alta
18	impostazione di funzionamento del sistema	0, 1, 2	2	0=sistema Posteriore 1 = sistema Anteriore 2 = selezione automatica***
*** NOTA: Questa selezione permette al display di impostarsi in automatico in funzione del ponticello presente sulla unità Slave. Ponticello unito =Frontale, Ponticello tagliato =Posteriore				

Questo prodotto rispetta le normative CE in accordo con le direttive 2014/53/EU:

Homologation: 10R-05 10498 Technical report No.: 260094-18-TAC  
10R-05 10499 Technical report No.: 260082-18-TAC

### Specifiche tecniche unità e sensori - Technical Data Sensors end main unit

Voltaggio di alimentazione ..... 9 - 30V  
Consumo (solo quando accenso) ..... 100mA max  
Range di temperature ..... -30/+80°C  
Frequenza ultrasuoni ..... 40KHz  
Frequenza trasmissione ..... 868 Mhz

### Specifiche tecniche display - Technical Data display

Voltaggio di alimentazione ..... 9 - 30V  
Consumo (solo quando accenso) ..... 100mA max  
Range di temperature ..... -20/+70°C  
Frequenza trasmissione ..... 868 MHz



### - Accensione icona antenna sul display

Si accende l'icona "antenna" quando il display non riesce a ricevere il segnale trasmesso dalla centralina posteriore. Tale condizione potrebbe manifestarsi in caso di un disturbo in frequenza o di una posizione errata delle centraline.

Verificare inoltre che la centralina posteriore sia alimentata correttamente.

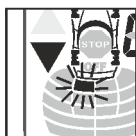

### - Lampeggio continuo di una icona "Stop Zona" sul display

La segnalazione di uno o più sensori difettosi è mostrata sul display con un lampeggio costante del segmento di stop in corrispondenza dei sensori guasti. Comunque Il sistema continua a funzionare parzialmente. Se la segnalazione persiste occorre verificare il sensore difettoso.



### - Non si verificano segnalazioni visive e sonore di ostacoli.

Verificare che il simbolo Speaker sia spento e che non vi siano una o entrambe le scritte OFF sulla icona vettura. In tal caso premere il pulsante corrispondente del display.



### - Il display si accende con la scritta "LE"

Le centraline potrebbero non essere auto-apprese al display; eseguire quindi la procedura di auto apprendimento e verificare che alla successiva riaccensione vengano rilevate dal display.

### - False segnalazione dovute a:

Sensori sporchi (fango, neve ecc.)	Pulire i sensori.
Sensori posizionati troppo in basso (vedi pagine 7 e 10)	Usare i supporti angolati per inclinare i sensori verso l'alto.
Il lato posteriore dei sensori "tocca" il telaio della vettura (vedi note pagina 6)	Separare i sensori dal telaio della vettura. <u>Non</u> devono assolutamente toccarsi.
Rilevamento di una parte della vettura che si vuole escludere (gancio di traino, ruota di scorta....vedi note pagina 6)	Incrementare la funzione n.11 fino a risolvere il problema

### NOTE

La ditta costruttrice declina ogni responsabilità per guasti o anomalie di funzionamento del prodotto o dell'impianto elettrico della vettura dovuti ad una cattiva installazione o ad un superamento delle caratteristiche indicate.

**LA DITTA COSTRUTTRICE si riserva il diritto di effettuare variazioni in qualsiasi momento si rendessero necessarie senza l'obbligo di darne comunicazione.**

All'inserimento della retromarcia, il sistema elettronico di parcheggio si attiva completamente tramite una segnalazione acustica e sul display si avrà l'accensione del simbolo freccia inferiore. L'eventuale ostacolo è segnalato, a livello uditivo e visivo dal display. All'avvicinarsi verso uno ostacolo si distinguono le zone R1, R2, R3 (vedere disegno Zone di Rilevazione) grazie alla frequenza del suono ed anche all'indicazione grafica sul display.

(es. Suono continuo - STOP zona RC).

**!!! ATTENZIONE !!!: anche con il sistema di parcheggio installato è necessario guardare nei dintorni del veicolo durante la manovra. Il sistema non rileva piccoli ostacoli e oggetti con scarsa capacità di riflessione.**

### Funzionalità display

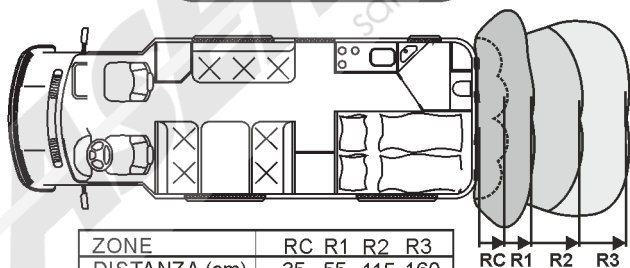

RC = Tono continuo

#### TASTO SX:

- Disattivazione/Attivazione dell'indicazione ACUSTICA e VISIVA del sistema di parcheggio.

#### TASTO DX:

- Disattivazione/Attivazione dell'indicazione ACUSTICA e VISIVA del sistema di parcheggio posteriore.



#### ATTENZIONE:

se il simbolo dell'antenna rimane acceso nel display,  
il sistema non funziona in maniera ottimale,  
**FARE ATTENZIONE DURANTE  
LA MANOVRA DI PARCHEGGIO**

The units using the "wireless" communications between them. The display must recognize the units installed in the same vehicle, learning the unique code of identification.

### Learning procedure Slave unit to Display

Turn on the ignition key and put on the reverse gear, only now hold pushed both the display buttons for 2sec; will appear the "LE" written (A), now the icon "lower arrow" will appear on the display left side so to identify the correct learning of the Rear control unit (B).

Now the unit is learned at the display, to confirm the learning turn off the ignition key of the vehicle.



(A)



(B)

### IMPORTANT AFTER THE INSTALLATION

With the factory setting you must install the units starting from the left side of the vehicle.

If instead the installation of one or both the units is putted on the right side you must modify the factory setting to obtain the correct visualization of the obstacles on the display.

Is necessary so change the function N.9 for the rear unit.

**NOTE:** The programmable functions on the units previous learned are not deleted at every new next learning procedure.

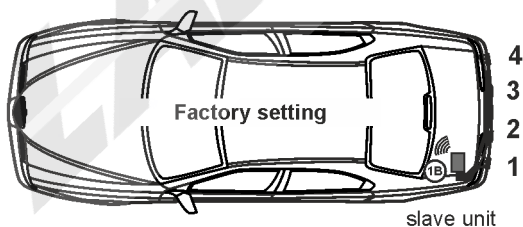

slave unit

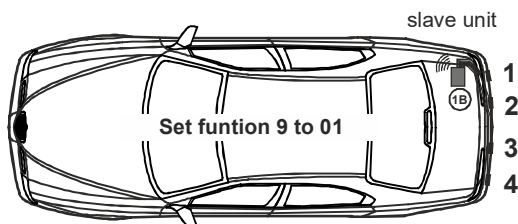

slave unit

**WARNING!** Unprofessional manipulation with parameters can seriously limit utility of device!

**Procedure**

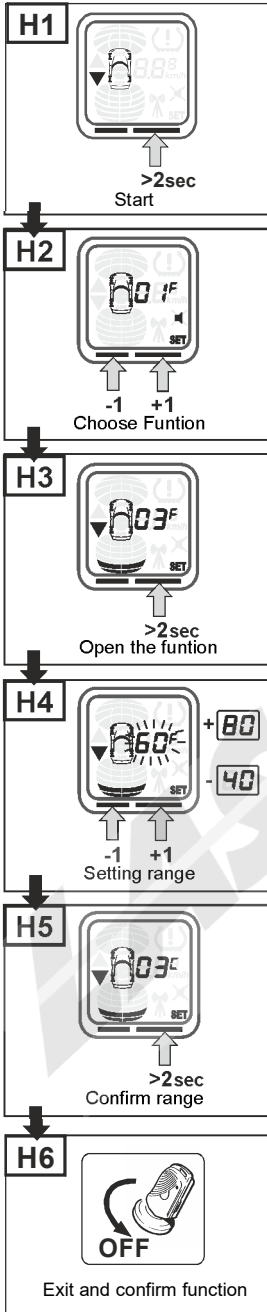

Function	Factory setting	Range	Note
01 → >2sec		From 00 To 02	<ul style="list-style-type: none"> <li>✕ 0=off</li> <li>▲ 1=low</li> <li>■ 2=high</li> </ul>
02			
03 → >2sec		From 20 To 80	Distance range Note, Display shows 20 -80
04 → >2sec		From 50 To 95	Distance range corner sensors
05			
06 → >2sec		From 35 To 70	Range stop zone
07			
08			
09 → >2sec		From 00 To 01	
10 → >2sec		From 01 To 05	Display color 1=red 2=green 3=blue 4=amber 5=white
11 → >2sec		From 00 To 03	
12			
13			
14			
15			
16			
17 → >2sec		From 00 To 03	<ul style="list-style-type: none"> <li>0=Very Low sensitivity</li> <li>1=Low sensitivity Rear</li> <li>2=Standard sens. Rear</li> <li>3=High sensitivity Rear</li> </ul>
18 → >2sec		From 00 To 02	<ul style="list-style-type: none"> <li>0=Rear system</li> <li>1=Front system</li> <li>2=Automatic selection</li> </ul>



NUM.	DESCRIPTION	RANGE	FACT. SET.	NOTE
1	speaker volume	0, 1, 2	2	0=off, 1=low, 2=high
3	range of rear central sensor	120 - 180 [cm]	160	the display show 20 - 80
4	range of corner sensor	50 - 95 [cm]	60	
6	rear STOP* zone width	35 - 70 [cm]	35	
*STOP zone = distance within you must stop the vehicle, signalled by a continuous tone. (The distances below this limit aren't more displayed)				
9	rear unit installing position	0, 1	0	0 / 1 = left / right
10	back-light display color	1 - 5	3	1 = red, 2 = green 3 = blue, 4 = amber, 5 = white
11	suppression of spare wheel indication	0, 1, 2, 3	0	**
** NOTE: This function allows to eliminate false detection due to the presence of: Spare wheel trailer hook.				
14	additional display features	0, 1, 2, 3, 4	0	0 = function not activated 1 = communication check 2 = speed indication* 3 = odometric pulse learning* 4 = SW version (0 - 9)
17	sensitivity of rear sensors	0,1, 2, 3,	1	0=Very low 1=low, 2=standard, 3=high
18	selection system model	0, 1, 2	2	0=Rear System 1= Front System 2= Automatic selection***
*** NOTE: This function selected the system automatically trough the brown loop on the Slave unit . With loop =Front unit, without loop =Rear				

The product is marked with the CE marking according to the directive 2014/53/EU:

Homologation: 10R-05 10498 Technical report No.: 260094-18-TAC  
10R-05 10499 Technical report No.: 260082-18-TAC

#### Technical Data Sensors and main unit

Power supply.....	9 - 30V
Current consumption.....	100mA max
Range of operational temperatures.....	-30/+80°C
Frequency of the ultrasound.....	.40KHz
Frequency trasmission .....	868 Mhz

#### Technical Data display

Power supply.....	9 - 30V
Current consumption.....	100mA max
Range of operational temperatures.....	-20/+70°C
Frequency trasmission .....	868 MHz



### - Turning ON of the aerial icon on the display

The aerial icon switches ON when the display doesn't able to receive the emitted signal from the rear/front unit. This condition may happen when there is a radiofrequency disturbance or due to a wrong position of the units into the vehicle.

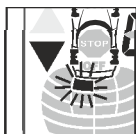

### - Faulty sensors signalling

The signalling of one or more faulty sensors is showed on the display with a constant flashes of the "stop" FC and/or RC zone. However the system continues to work partially. If the signalling continues, is necessary bring the vehicle to an authorized center for the checking of the system.



### - The display switch On but doesn't detect any obstacle.

Verify that the Speaker icon is OFF; moreover the both "OFF" written are not present on the vehicle display.



### - The display shows "LE"

The slave unit may not be self-learned on the display; then carry out the self-learning procedure and check that at the next power-up they are detected by the display.

### If irregular false obstacle indication occurs, it can be one of the following problems:

Dirty sensors (mud, snow, ice, etc..)	Clean the sensor with a suitable cloth.
Sensors installed too low (see sensors installations page)	Use angled supports to tilt the sensors upward. If there is still the problem select the functions 03 and/or 04 and/or 17.
Rear side of sensors in contact with chassis of vehicle	Separate sensors from the body of the vehicle. <u>They must not touch it.</u>

### NOTES

The manufacturer will not be held responsible for defect or malfunctions of the product or car electrical system due to incorrect installation or having gone beyond the limits indicated in the technical data.

**THE MANUFACTURER RESERVES THE RIGHT AT ANY TIME TO MAKE CHANGES DEEMED NECESSARY WITHOUT PRIOR NOTICE.**

After shifting into reverse gear you can hear control signal and on the display will light ON the "▼" lower arrow. Now, either front and rear sensor are activated.

An eventual obstacle is signaled audibly / visually by display. Nearing to an obstacle can be recognized the R3, R2, R1, RC zones and/or the F2, F1, FC zones by the different frequency of the sound and at the graphic indication on display.

(Example: Continuous tone - STOP zone RC / FC).

**!!! WARNING !!!: Even with electronic parking system installed it is necessary to watch surroundings of the vehicle carefully during manoeuvring. Small obstacles and items with low reflectance do not have to be captured by the system.**

### Display functionality

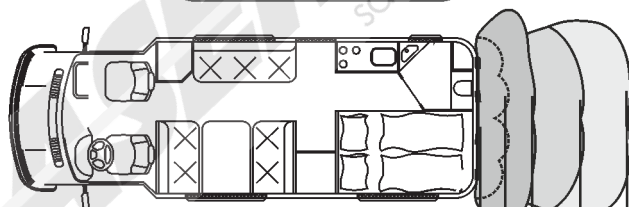

ZONE	RC	R1	R2	R3
DISTANCE (cm)	35	55	115	160

RC R1 R2 R3  
RC = Continuous tone

#### LEFT BUTTON:

- Activation/Deactivation of the frontal acoustic/visual indication of the electronic parking system .

#### RIGHT BUTTON:

- Activation/Deactivation of the rear acoustic/visual indication of the electronic parking system





**WARNING:**  
If the aerial icon remains turned ON on the display,  
the system doesn't work optimally,  
**PAY ATTENTION DURING  
THE PARKING MANOEUVRING**

**AVVERTENZE PER L'INSTALLAZIONE 4019F-LCD anteriore**  
**Unità SLAVE con ponticello marrone unito (impostazione di fabbrica)**  
**INSTALLATION NOTE 4019F-LCD front**  
**Unit SLAVE with brown loop connected (factory setup)**

  Prestare attenzione alla presenza di "radar" posti dietro al paraurti, posizionare i sensori senza coprire l'area davanti a questi dispositivi. (verificare se sono presenti note del produttore)

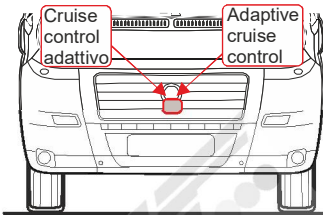



Pay attention to the presence of "radar" placed behind the bumper, don't fix the sensor in front this unit (check if there are any manufacturer's notes)

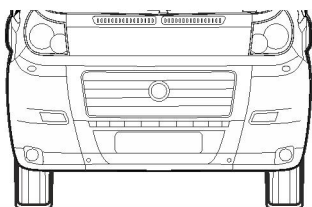

  Non installare su veicoli con particolari sporgenze date da porta targa o predisposizioni incassate si consiglia di consultare il manuale di istruzione.

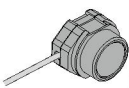
Pay attention to vehicles with protuberance refer to the instructions manual.



Fare attenzione all'eventuale presenza del longerone in ferro dietro al paraurti. Non fare appoggiare la parte posteriore del sensore al ferro.

Pay attention in case of an iron strengthening bar behind the bumper of the vehicle. Make sure that the back of the sensor does not touch the iron bar.

**B1**

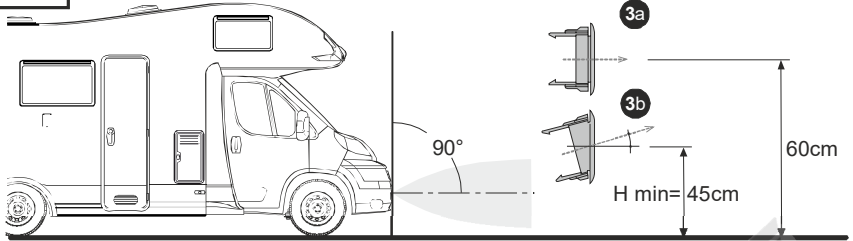

**B2**

4 sensori posteriori standard / 4 rear standard sensors

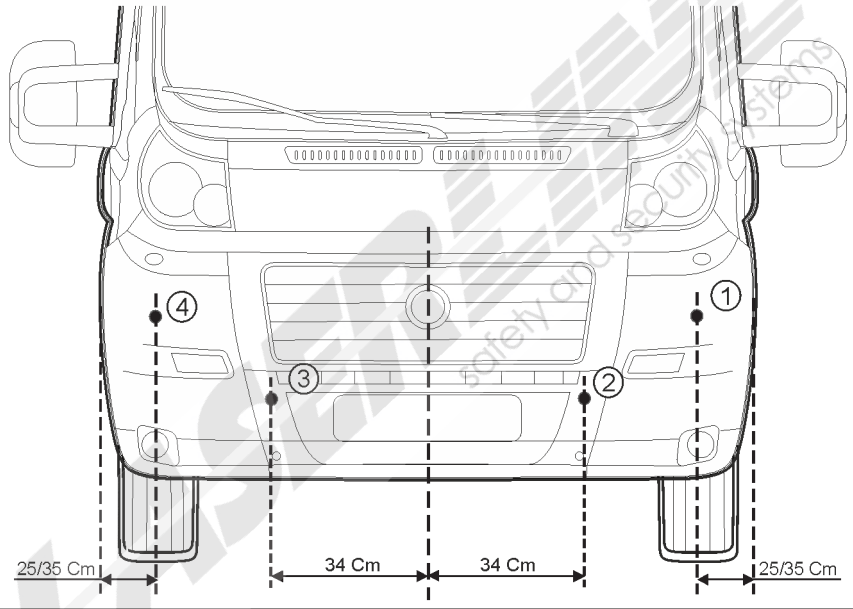

H

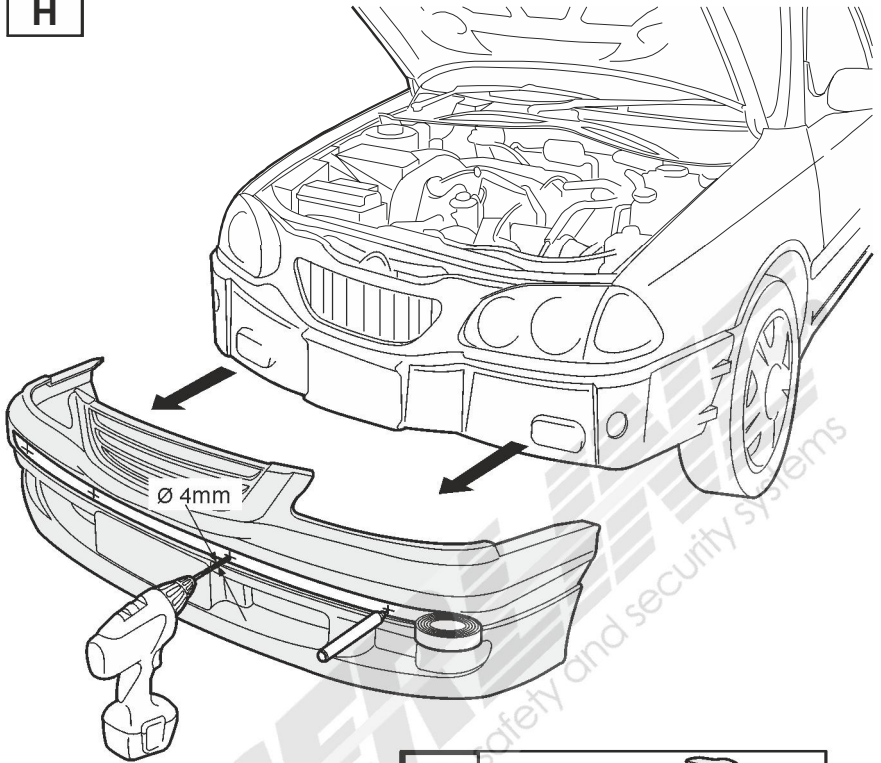

OPTIONAL AL18  
"Raccomandato"  
"Recommended"

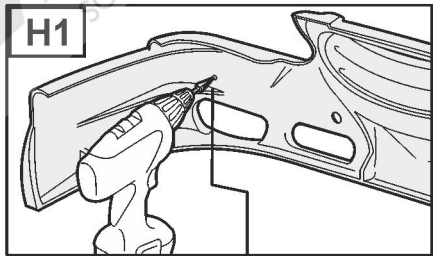

18mm

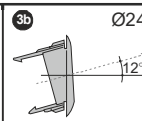
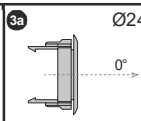
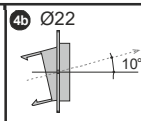
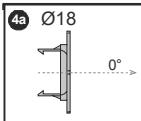
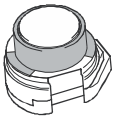

16mm

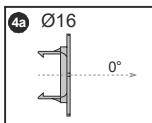
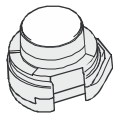

OPTIONAL AL16  
"Raccomandato"  
"Recommended"

# INSTALLAZIONE SENSORI ANTERIORI / FRONT SENSORS INSTALLATION

L

Marrone  
Brown  
Blu/Nero  
Blue/Black

ABS

Connessione  
opzionale  
Giallo/nero  
Optional  
connection  
Yellow/Black

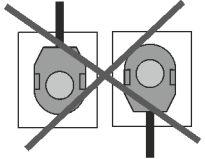
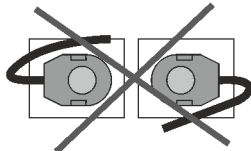
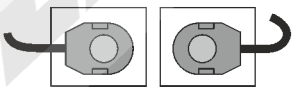
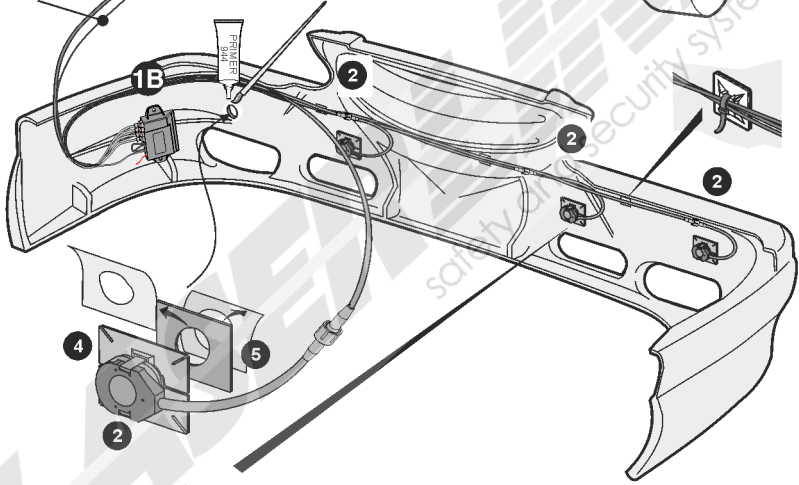

L1

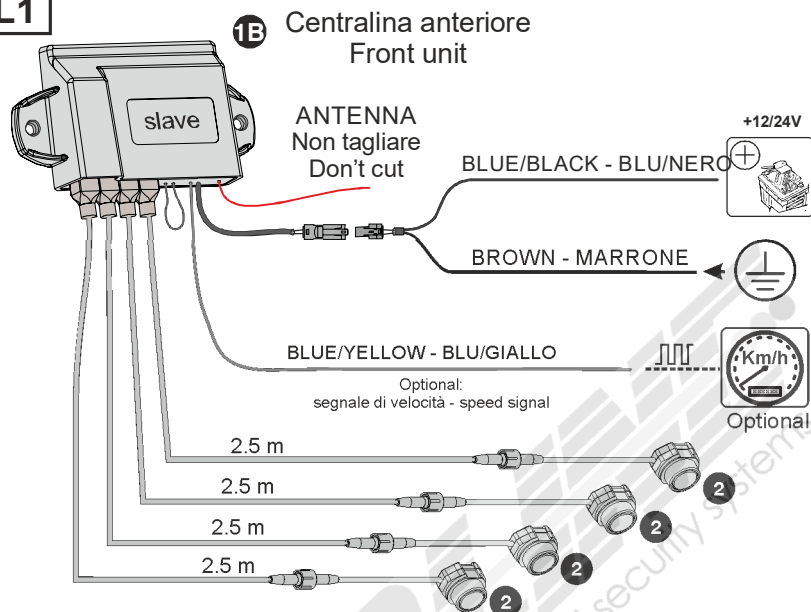

NOTA: il positivo può essere collegato al positivo sottochiave o al positivo fisso della batteria. L'odometro può essere collegato **solo in alternativa** al collegamento con la centralina principale (1A), quando il segnale non è reperibile in abitacolo.

NOTE: the positive can be connected to the ignition key or to the positive of the battery. The speed signal can be connected to the Front control unit **only if it is not available** in the cockpit. If possible, prefer the connection to the Master unit (1A).

## MODALITÀ DI COLLEGAMENTO / CONNECTION

F

### DISPOSIZIONE DEL KIT NEL VEICOLO KIT PLACEMENT IN THE VEHICLE

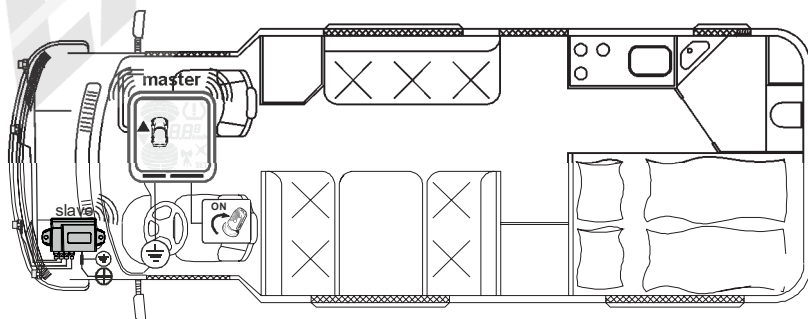



# POSIZIONAMENTO DISPLAY / DISPLAY POSITION

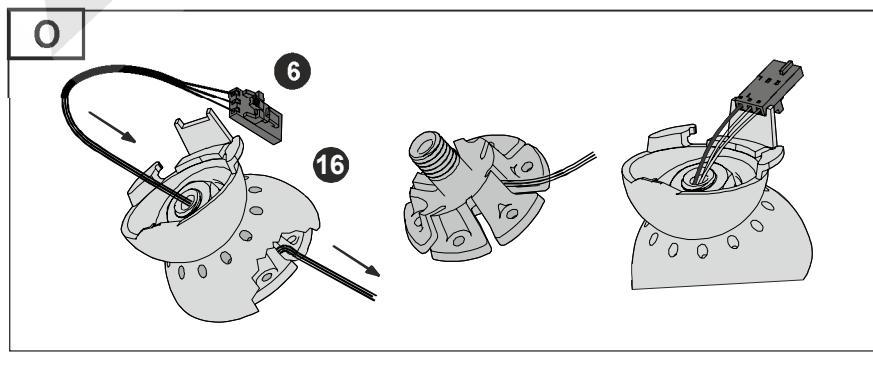
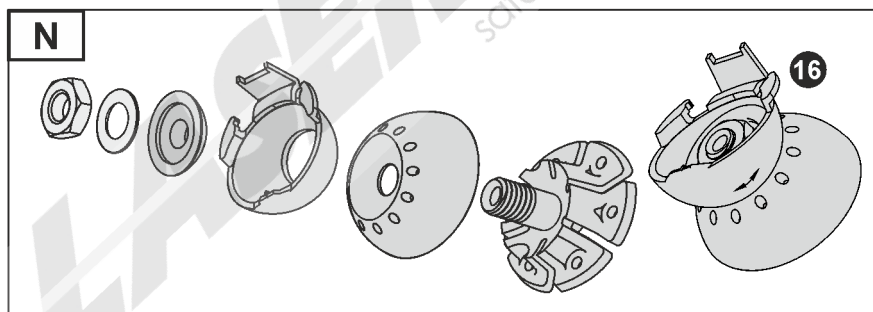
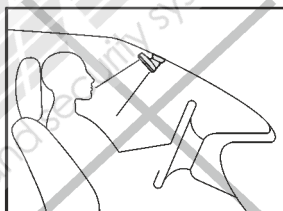
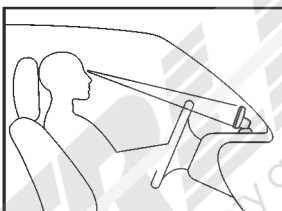
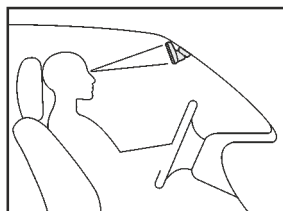
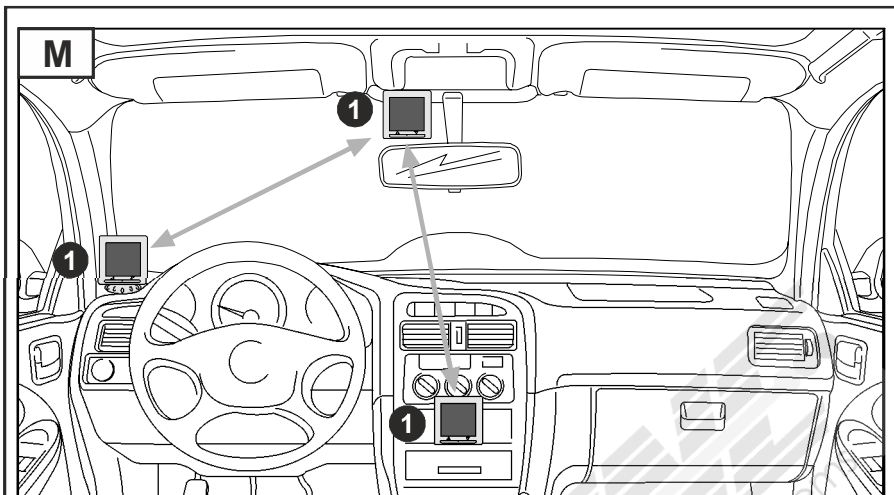

# POSIZIONAMENTO DISPLAY / DISPLAY POSITION

**P**

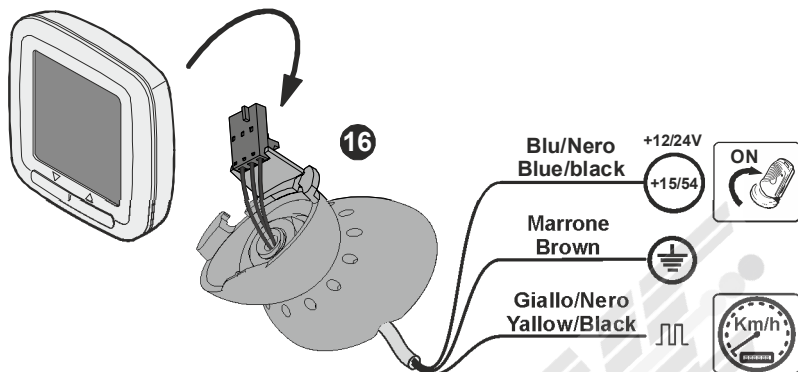

**Q1**

**17**

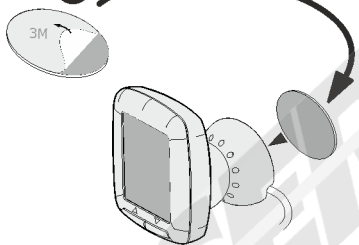

**Q2**

**15**

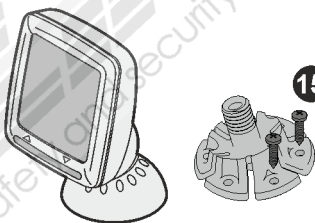

**R**

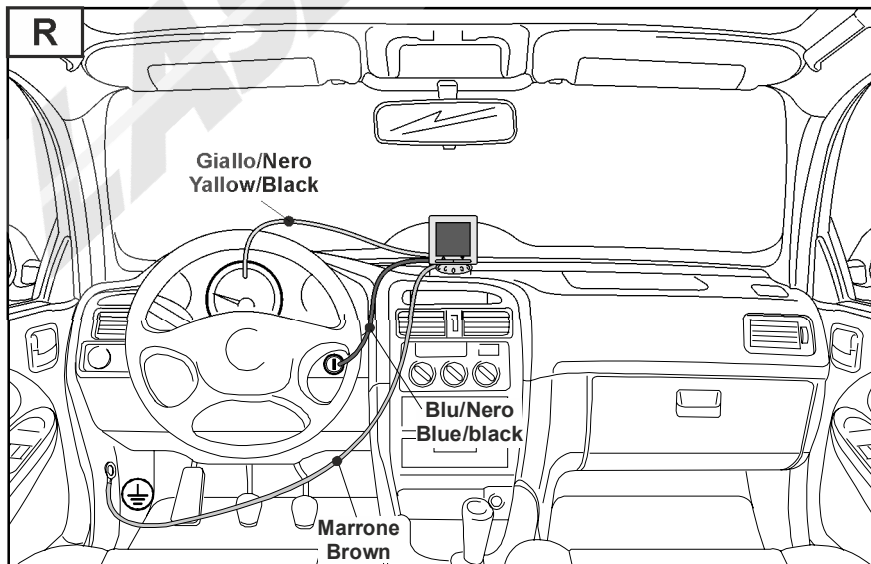

Le centraline utilizzano il sistema "senza fili" per dialogare tra loro. Il display deve riconoscere le centraline installate nello stesso veicolo, apprendendo il loro codice univoco di identificazione.

### Procedura di apprendimento della centralina al display

Alimentare la centralina anteriore; nel caso in cui la centralina fosse già stata collegata precedentemente è necessario togliere (per almeno 2sec.) e ridare l'alimentazione per permettere al sistema anteriore di trasmettere il codice univoco di identificazione. , solo ora premere per 2sec. entrambi i pulsanti sul display; apparirà la scritta "LE" (A), dopodiché l'icona con il simbolo "freccia superiore" apparirà nella parte sinistra del display (B) così ad identificare il corretto apprendimento della centralina.

Ora la centralina è appresa al sistema, per confermare l'apprendimento spegnere il quadro della vettura.

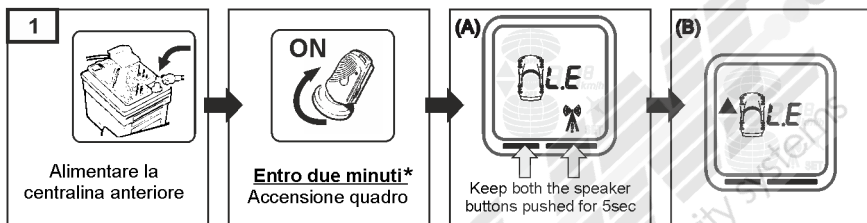

**\*Importante:** La procedura di auto-apprendimento deve essere svolta entro 2 minuti dalla alimentazione della centralina anteriore. Dopo questo tempo la centralina anteriore non emetterà il proprio codice di riconoscimento. Per ripristinare la situazione iniziale occorre togliere e ridare l'alimentazione alla centralina anteriore e ripartire con la procedura dal punto 1.

### VERIFICHE IMPORTANTI DOPO L'INSTALLAZIONE

1) Il sistema è impostato da fabbrica per il montaggio delle centraline nel lato guida dei paraurti. Se invece l'installazione della centralina viene effettuata sul lato passeggero occorre modificare le impostazioni di fabbrica per ottenere una corretta visualizzazione degli ostacoli sul display.

Cambiare quindi l'impostazione della funzione N.8 per la centralina anteriore.

**NOTA:** le funzioni programmabili non vengono cancellate ad ogni nuovo apprendimento se viene mantenuto lo stesso display.



unità slave  
per anteriore

unità slave  
per anteriore



# IMPOSTAZIONE DELLE FUNZIONI

## Procedura di selezione

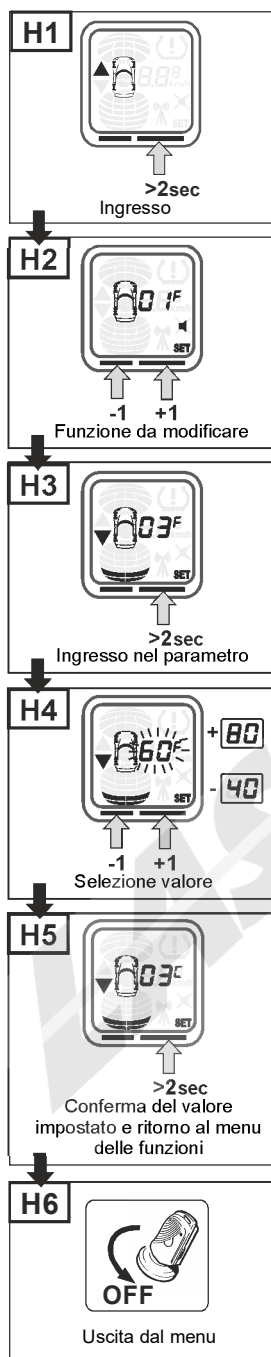

Funzione	Impostazione di fabbrica	Valori	Note
<b>01</b> → >2sec		DA <b>00</b> A <b>02</b>	× 0=spento ▲ 1=basso ▲ 2=alto
<b>02</b> → >2sec		DA <b>50</b> A <b>95</b>	raggio di azione sensori centrali
<b>03</b>			
<b>04</b> → >2sec		DA <b>50</b> A <b>95</b>	raggio di azione sensori laterali
<b>05</b> → >2sec		DA <b>35</b> A <b>50</b>	raggio di Stop anteriore
<b>06</b>			
<b>07</b> → >2sec		DA <b>00</b> A <b>01</b>	0=rilevamento singolo 1=rilevamento continuo
<b>08</b> → >2sec		DA <b>00</b> A <b>01</b>	00  01
<b>09</b>			
<b>10</b> → >2sec		DA <b>01</b> A <b>05</b>	Colori display 1=rosso 2=verde 3=blu 4=ambra 5=bianco
<b>11</b>			
<b>12</b> → >2sec		DA <b>01</b> A <b>25</b>	Impulsi metro
<b>13</b> → >2sec		DA <b>00</b> A <b>60</b>	Tempo sensori attivi
<b>14</b> → >2sec		DA <b>00</b> A <b>04</b>	0=OFF 1=controllo RF 2=mostra Km/h 3=rilevazione velocità 4=versione software
<b>15</b> → >2sec		DA <b>00</b> A <b>01</b>	0=odometro display 1=odometro centrale ant
<b>16</b> → >2sec		DA <b>01</b> A <b>03</b>	1=Bassa sensibilità ant. 2=Media sensibilità ant. 3=Alta sensibilità ant.
<b>17</b>			
<b>18</b> → >2sec		DA <b>00</b> A <b>02</b>	0= sistema Posteriore 1= sistema Anteriore 2= Selezione automatica

NUM.	DESCRIZIONE	RANGE	FACT. SET.	NOTE
1	volume dello speaker	0, 1, 2	2	0=spento, 1=basso, 2=alto
2	raggio dei sensori centrali frontali	50 - 95 [cm]	80	
4	raggio dei sensori laterali	50 - 95 [cm]	60	
5	zona STOP* frontale	35 - 50 [cm]	35	
* ZONA STOP = distanza in cui bisogna arrestare il veicolo segnalato da un suono continuo. (Le distanze al di sotto di questo limite non sono più visualizzate)				
7	segnalazione ostacoli anteriori	0, 1	0	0 = rilevamento singolo 1 = rilevamento continuo
8	installazione centraline anteriore	0, 1	1	0 / 1 = destra / sinistra
10	colore illuminazione display	1 - 5	3	1 = rosso, 2 = verde 3 = blu, 4 = ambra, 5 = bianco
12	numero impulsi odometrici per metro	1,0 - 99,0	3,0	(Impulsi per metro)
13	tempo funzionamento sensori frontali	0, 10 - 60 [s]	0	0 = funzione non attiva
14	funzione supplementari display	0, 1, 2, 3, 4	0	0 = funzione non attiva 1 = controllo trasmissione 2 = Indicazione velocità** 3 = apprendimento impulsi odometrici
** Queste funzioni e disponibili solo se il segnale odometrico è stato collegato al display. 4 = Versione SW (0 - 9)				
15	collegamento segnale odometrico	0, 1	0	0/1 = display / cent. Ant.
16	sensibilità lettura ostacoli anteriore	1, 2, 3	2	1=bassa, 2=media, 3=alta
18	impostazione di funzionamento del sistema	0, 1, 2	2	0=sistema Posteriore 1= sistema Anteriore 2= selezione automatica***
*** NOTA: Questa selezione permette al display di impostarsi in automatico in funzione del ponticello presente sulla unità Slave. Ponticello unito =Frontale, Ponticello tagliato =Posteriore				

Questo prodotto rispetta le normative CE in accordo con le direttive 2014/53/EU:

Homologation: 10R-05 10498 Technical report No.: 260094-18-TAC  
10R-05 10499 Technical report No.: 260082-18-TAC

### Specifiche tecniche unità e sensori - Technical Data Sensors end main unit

Voltaggio di alimentazione ..... 9 - 30V  
Consumo (solo quando accenso) ..... 100mA max  
Range di temperature ..... -30/+80°C  
Frequenza ultrasuoni..... 40KHz  
Frequenza trasmissione ..... 868 Mhz

### Specifiche tecniche display - Technical Data display

Voltaggio di alimentazione ..... 9 - 30V  
Consumo (solo quando accenso) ..... 100mA max  
Range di temperature ..... -20/+70°C  
Frequenza trasmissione ..... 868 MHz



### - Accensione icona antenna sul display

Si accende l'icona "antenna" quando il display non riesce a ricevere il segnale trasmesso dalla centralina posteriore. Tale condizione potrebbe manifestarsi in caso di un disturbo in frequenza o di una posizione errata delle centraline.

Verificare inoltre che la centralina posteriore sia alimentata correttamente.

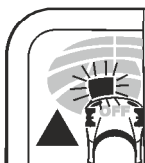

### - Lampeggio continuo di una icona "Stop Zona" sul display

La segnalazione di uno o più sensori difettosi è mostrata sul display con un lampeggio costante del segmento di stop in corrispondenza dei sensori guasti. Comunque Il sistema continua a funzionare parzialmente. Se la segnalazione persiste occorre verificare il sensore difettoso.



### - Si verificano false segnalazioni di ostacoli durante la marcia della vettura.

Verificare che il simbolo freccia superiore si spenga quando si supera la velocità di 10Km/h o dopo che è trascorso il tempo "T" di funzionamento dei sensori anteriori.

OFF



### - Non si verificano segnalazioni visive e sonore di ostacoli.

Verificare che il simbolo Speaker sia spento e che non vi siano una o entrambe le scritte OFF sulla icona vettura. In tal caso premere il pulsante corrispondente del display.



### - Il display si accendere con la scritta "LE"

Le centraline potrebbero non essere auto-apprese al display; eseguire quindi la procedura di auto apprendimento e verificare che alla successiva riaccensione vengano rilevate dal display.

**In caso di rilevazione di falsi ostacoli, ci può essere uno dei seguenti problemi:**

Sensori sporchi (fango, neve, ghiaccio, ecc.)	Pulire i sensori con un panno adeguato.
Sensori posizionati troppo in basso	Usare i supporti angolati per inclinare i sensori verso l'alto. Se sussiste ancora il problema utilizzare le funzioni 17 e/o 02 per eliminare la segnalazione.
Il lato posteriore dei sensori "tocca" il telaio della vettura (vedi note pagina 3)	Separare i sensori dal telaio della vettura. <u>Non devono assolutamente toccarsi.</u>

All'accensione del quadro strumenti si attivano i sensori frontali e sul display si avrà l'accensione del simbolo freccia superiore e il disegno vettura. Solo in presenza di un ostacolo si avrà una immediata segnalazione acustica e visiva.

L'eventuale ostacolo è segnalato, a livello uditivo e visivo dal display. All'avvicinarsi verso un ostacolo si distinguono le zone F1, F2, (vedere disegno Zone di Rilevazione) grazie alla frequenza del suono ed anche all'indicazione grafica sul display.

(es. Suono continuo - STOP zona FC).

**!!! ATTENZIONE !!!: anche con il sistema di parcheggio installato è necessario guardare nei dintorni del veicolo durante la manovra. Il sistema non rileva piccoli ostacoli e oggetti con scarsa capacità di riflessione.**

### Funzionalità display

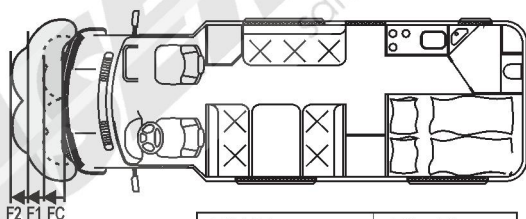

FC = Tono continuo

ZONE	FC	F1	F2
DISTANZA (cm)	35	60	80

#### TASTO SX:

- Disattivazione/Attivazione dell'indicazione ACUSTICA e VISIVA del sistema di parcheggio.

#### TASTO DX:

- Disattivazione/Attivazione dell'indicazione ACUSTICA e VISIVA del sistema di parcheggio posteriore.



#### ATTENZIONE:

se il simbolo dell'antenna rimane acceso nel display, il sistema non funziona in maniera ottimale, FARE ATTENZIONE DURANTE LA MANOVRA DI PARCHEGGIO

The units using the "wireless" communications between them. The display must recognize the units installed in the same vehicle, learning the unique code of identification.

### learning procedure Slave unit to Display

Supply the front unit; if it is already connected is necessary to put off (for 2 sec.) and reconnect the front unit allowing so at the system transmit the unique code of identification.

Turn on the ignition key, only now hold pushed both the display buttons for 2sec; will appear the "LE" written (A); now the icon "upper arrow" will appear on the display left side so to identify the correct learning of the Front control unit (B).

Now the unit is learned at the display, to confirm the learning turn off the ignition key of the vehicle.

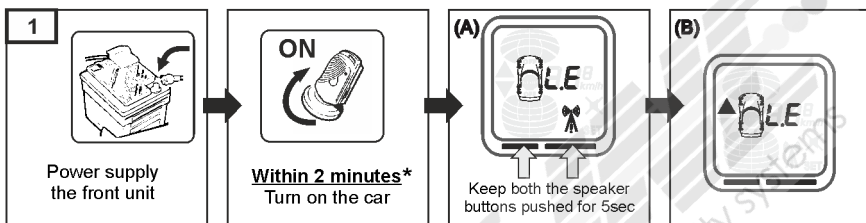

**\*Important:** the self-learning procedure can be executed within 2 minutes since the powering of the front unit. After, the front unit will not emit its recognition code. To get back to the initial situation, remove and subsequently restore power to the front unit and repeat the procedure from point 1.

### IMPORTANT AFTER THE INSTALLATION

With the factory setting you must install the units starting from the left side of the vehicle.

If instead the installation of one or both the units is putted on the right side you must modify the factory setting to obtain the correct visualization of the obstacles on the display.

Is necessary so change the function N.8 for the rear unit.

**NOTE:** The programmable functions on the units previous learned are not deleted at every new next learning procedure.

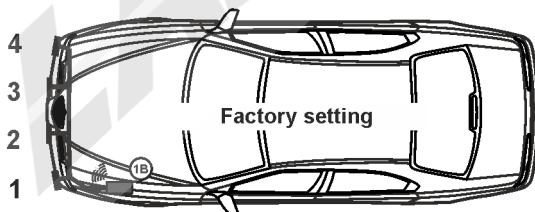

Front slave unit

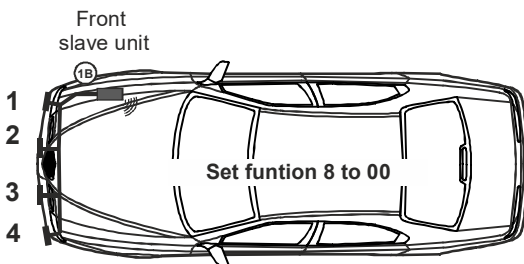







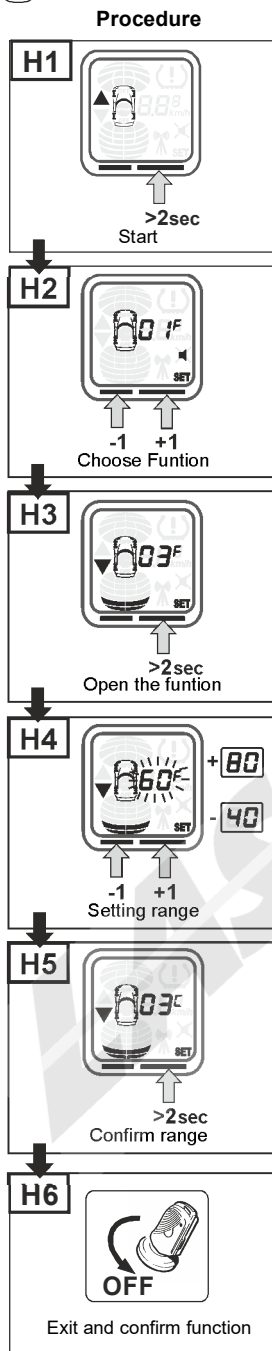









Front slave unit



# PROGRAMMABLE FUNCTION PROCEDURE



Funtion	Factory setting	Range	Note
<b>01</b> → >2sec		From <b>00</b> To <b>02</b>	× 0=off ▲ 1=low ▼ 2=high
<b>02</b> → >2sec		From <b>50</b> To <b>95</b>	Distance range
<b>03</b>			
<b>04</b> → >2sec		From <b>50</b> To <b>95</b>	Distance range
<b>05</b> → >2sec		From <b>35</b> To <b>50</b>	Range stop zone
<b>06</b>			
<b>07</b> → >2sec		From <b>00</b> To <b>01</b>	Obstacle indication 0=single detection 1=continuous detection
<b>08</b> → >2sec		From <b>00</b> To <b>01</b>	00%  01 
<b>09</b>			
<b>10</b> → >2sec		From <b>01</b> To <b>05</b>	Display color 1=red 2=green 3=blue 4=amber 5=white
<b>11</b>			
<b>12</b> → >2sec		From <b>03</b> To <b>90</b>	Pulses meter 
<b>13</b> → >2sec		From <b>00</b> To <b>60</b>	Time active sensors 
<b>14</b> → >2sec		From <b>00</b> To <b>04</b>	0=OFF 1= Check R.F. 2=Shows Km/h 3=Speed calibration 4=Software version
<b>15</b> → >2sec		From <b>00</b> To <b>01</b>	0=Wire speed on display 1=Wire speed on f. Unit
<b>16</b> → >2sec		From <b>01</b> To <b>03</b>	1=Low sensitivity Front 2=Standard sens. Front 3=High sensitivity Front
<b>17</b>			
<b>18</b> → >2sec		From <b>00</b> To <b>02</b>	0=Rear system 1=Front system 2=Automatic selection

NUM.	DESCRIPTION	RANGE	FACT. SET.	NOTE
1	speaker volume	0, 1, 2	2	0=off, 1=low, 2=high
2	range of front central sensor	50 - 95 [cm]	80	
4	range of corner sensor	50 - 95 [cm]	60	
5	front STOP* zone width	35 - 50 [cm]	35	
*STOP zone = distance within you must stop the vehicle, signaled by a continuous tone. (The distances below this limit aren't more displayed)				
7	front obstacle indication	0, 1	0	0 = single detection 1 = continuous detection
8	front unit installing position	0, 1	1	1 / 0 = left / right
10	backlight display color	1 - 5	3	1 = red, 2 = green 3 = blue, 4 = amber, 5 = white
12	number speed signal pulses	1,0 - 99,0	3,0	(Pulses/m)
13	delay of front sensor deactivation	0, 10 - 60 [s]	0	0 = function not activated
14	additional display features	0, 1, 2, 3, 4	0	0 = function not activated 1 = communication check 2 = speed indication* 3 = odometric pulse** 4 = SW version (0 - 9)
** These functions are available only if the speed signal is connected at the display.				
15	Speed signal connection	0, 1	0	0 / 1 = display / front unit
16	sensitivity of front sensors	1, 2, 3,	2	1=low, 2=standard, 3=high
18	selection system model	0, 1, 2	2	0=Rear System 1= Front System 2= Automatic selection***

\*\*\* NOTE: This function selected the system automatically through the brown loop on the Slave unit. With loop =Front unit, without loop =Rear

The product is marked with the CE marking according to the directive 2014/53/EU:

Homologation: 10R-05 10498 Technical report No.: 260094-18-TAC  
10R-05 10499 Technical report No.: 260082-18-TAC

### Technical Data Sensors and main unit

Power supply.....	9 - 30V
Current consumption.....	100mA max
Range of operational temperatures.....	-30/+80°C
Frequency of the ultrasound.....	.40KHz
Frequency transmission .....	868 Mhz

### Technical Data display

Power supply.....	9 - 30V
Current consumption.....	100mA max
Range of operational temperatures.....	-20/+70°C
Frequency transmission .....	868 MHz



### - Turning ON of the aerial icon on the display

The aerial icon switches ON when the display doesn't able to receive the emitted signal from the rear/front unit. This condition may happen when there is a radiofrequency disturbance or due to a wrong position of the units into the vehicle.

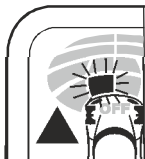

### - Faulty sensors signalling

The signalling of one or more faulty sensors is showed on the display with a constant flashes of the "stop" FC and/or RC zone. However the system continues to work partially. If the signalling continues, is necessary bring the vehicle to an authorized center for the checking of the system.



### - False detections while the vehicle is running.

Verify that the "upper arrow" icon turning OFF when the vehicle exceeds the speed of 10Km/h or after the timeout "T".



### - The display switch On but doesn't detect any obstacle.

Verify that the Speaker icon is OFF; moreover the both "OFF" written are not present on the vehicle display.



### - The display shows "LE"

The slave unit may not be self-learned on the display; then carry out the self-learning procedure and check that at the next power-up they are detected by the display.

**If irregular false obstacle indication occurs, it can be one of the following problems:**

Dirty sensors (mud, snow, ice, etc..)	Clean the sensor with a suitable cloth.
Sensors installed too low (see sensors installations page)	Use angled supports to tilt the sensors upward. If there is still the problem select the functions 02 and/or 17.
Rear side of sensors in contact with chassis of vehicle	Separate sensors from the body of the vehicle. <u>They must not touch it.</u>

### NOTES

The manufacturer will not be held responsible for defect or malfunctions of the product or car electrical system due to incorrect installation or having gone beyond the limits indicated in the technical data.

**THE MANUFACTURER RESERVES THE RIGHT AT ANY TIME TO MAKE CHANGES DEEMED NECESSARY WITHOUT PRIOR NOTICE.**

After switching the ignition key ON, front sensors are activated and on the display will light ON the "▲" upper arrow. Detection of obstacles and their signaling is launched immediately. Obstacles are signalled audibly / visually by display.

An eventual obstacle is signalled audibly / visually by display. Nearing to an obstacle can be recognized the F2, F1, FC zones by the different frequency of the sound and at the graphic indication on display.

(Example: Continuous tone - STOP zone FC).

**!!! WARNING !!!: Even with electronic parking system installed it is necessary to watch surroundings of the vehicle carefully during manoeuvring. Small obstacles and items with low reflectance do not have to be captured by the system.**

### Display functionality

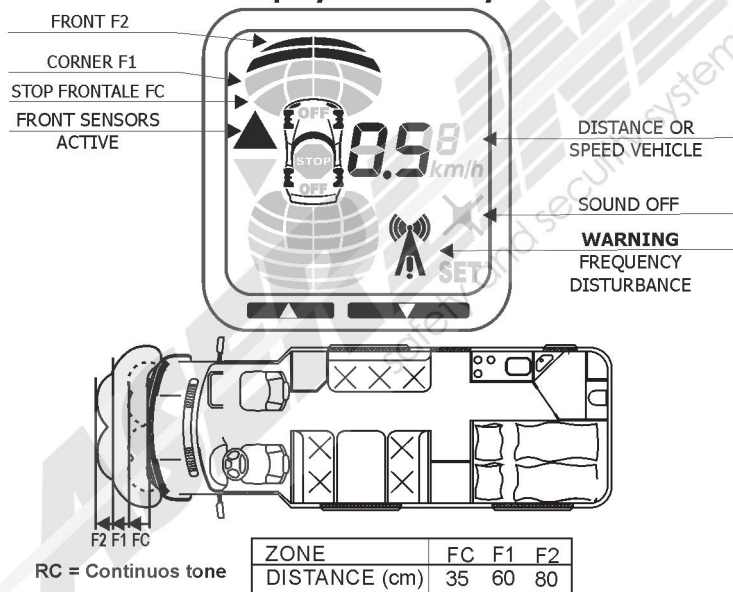

#### LEFT BUTTON:

- Activation/Deactivation of the frontal acoustic/visual indication of the electronic parking system .

#### RIGHT BUTTON:

- Activation/Deactivation of the frontal acoustic/visual indication of the electronic parking system



#### WARNING:

*If the aerial icon remains turned ON on the display, the system doesn't work optimally, PAY ATTENTION DURING THE PARKING MANOEUVRING*